



***BOSE***®



# RoomMatch™

Array Rigging Frames and Accessories  
Installation and Safety Guidelines  
Instrucciones de instalación y de seguridad  
Installation et instructions de sécurité  
Installations- und Sicherheitshinweise

 **This product is intended for installation by professional installers only!** This document is intended to provide professional installers with basic installation and safety guidelines for Bose RoomMatch™ loudspeakers in typical fixed-installation systems. Please read this document before attempting installation.

 **WARNING:** All Bose® products must be used in accordance with local, state, federal and industry regulations. It is the installer's responsibility to ensure installation of the loudspeakers and mounting system is performed in accordance with all applicable codes, including local building codes and regulations. Consult the local authority having jurisdiction before installing this product.

 **WARNING:** Unsafe mounting or overhead suspension of any heavy load can result in serious injury and equipment damage. It is the responsibility of the installer to evaluate the reliability of any mounting method used for their application. Only professional installers with the knowledge of proper hardware and safe mounting techniques should attempt to install any loudspeaker overhead.

## Guidelines for Permanent Installation of RoomMatch™ Array Module Loudspeakers

The installation information contained in this document is only a general guideline and cannot, as such, represent all requirements and precautions. Accordingly, anyone using this material assumes all liability and is expressly responsible for the safety of all loudspeaker array designs and mounting configurations applied in practice.

1. Prior to the installation of any overhead loudspeaker, a licensed professional engineer must approve the location and method of attachment to the building structure and confirm they are consistent with all building codes and regulations. Ensure the mounting surface and the method of attaching the loudspeaker system to the surface is capable of supporting the total weight of the system. A safety factor of 10:1 is recommended.
2. Obtain all mounting system components from reputable manufacturers. Select a mounting system appropriate for your loudspeaker system and its intended application. We recommend Bose mounting accessories when available. A licensed professional engineer must review the design and fabrication of any custom mounting hardware.
3. Bose RoomMatch™ array module loudspeakers feature an integrated side-plate rigging system, designed to facilitate loudspeaker array mounting by professional installers. Module to module connections should be made using only the integrated rigging side plates with the included M10 graded fasteners. Do NOT use SAE 3/8" size threaded hardware! Use only metric hardware. Fasteners should be metric Class 10.9 (load bearing rated) or equivalent. Unmarked (not rated for load bearing) fasteners should not be used.
4. Do not suspend loudspeaker using handles as attachment points. **Handles are NOT designed for load bearing!**
5. Use lock washers or a locking compound intended for hand disassembly, such as LOCTITE® THREADLOCKER BLUE 242® compound, for a vibration resistant assembly.
6. Fasteners should be tightened using torque of 35 to 40 foot-pounds (47 to 54 Newton-meters). Over-tightening the fasteners could result in irreparable damage to the cabinet and create an unsafe assembly.
7. Do not attempt to alter the threaded attachment points or re-thread the attachment points to accommodate any other thread size or type; doing so will compromise the safety while permanently damaging the loudspeaker.
8. Use a safety cable, separately attached to the cabinet, at a point not in common with the load bearing attachment points of the mounting system to the loudspeaker. This is recommended even if not required by local regulation. Consult a licensed professional engineer or a rigging professional for proper design and installation.

 **CAUTION:** Installed loudspeaker arrays require regular inspection and routine maintenance to ensure proper function and safe operation. Inspect mounting hardware and attachments for signs of corrosion, bending or any other condition that may decrease the structural integrity. Immediately replace worn or damaged components.

 **CAUTION:** Make no modifications to the loudspeakers or mounting accessories. Unauthorized alterations may compromise safety and could result in damage, injury, or death.

 **CAUTION:** Never exceed 8 RoomMatch modules using the integrated rigging side plates for arrays. Please refer to product labels and the Array Design and Installation Guide document for Working Load Limit data.

 **Sólo un instalador profesional deberá montar este producto.** Este documento ofrece a los instaladores profesionales instrucciones básicas de instalación y seguridad para los altavoces Bose RoomMatch™ en sistemas típicos de instalación fija. Lea este documento antes de intentar la instalación.

 **ADVERTENCIA:** Todos los productos Bose® deben utilizarse de acuerdo con las normas locales, estatales, federales e industriales. Será responsabilidad del instalador asegurarse de que la instalación de los altavoces y del sistema de montaje se realiza de acuerdo con todos los códigos aplicables, incluidos los códigos y normativas de construcción locales. Consulte a las autoridades locales pertinentes antes de instalar este producto.

 **ADVERTENCIA:** El montaje no seguro o la suspensión de cualquier carga pesada puede producir heridas graves y daños al equipo. Será responsabilidad del instalador evaluar la fiabilidad de cualquier método de montaje empleado en su aplicación. Sólo los instaladores profesionales con conocimiento de los accesorios adecuados y las técnicas de montaje seguro deberán intentar instalar cualquier altavoz en suspensión.

## Instrucciones para la instalación permanente del conjunto de altavoces modulares RoomMatch™



La información de instalación que contiene este documento ofrece sólo directrices generales y, por tanto, no puede representar todos los requisitos y precauciones. Por consiguiente, cualquiera que utilice este material asume expresamente toda la responsabilidad por la seguridad de todos los diseños de matriz de altavoces y de las configuraciones de montaje aplicadas en la práctica.

1. Antes de la instalación de cualquier altavoz en suspensión, un ingeniero profesional con licencia deberá aprobar la ubicación y el método de fijación a la estructura del edificio y confirmar que cumplen todos los códigos y normativas de construcción. Compruebe que la superficie de montaje y el método para fijar el sistema de altavoces a la superficie son capaces de soportar el peso total del sistema. Se recomienda aplicar un factor de seguridad de 10:1.
2. Consiga todos los componentes de montaje de fabricantes de confianza. Seleccione un sistema de montaje adecuado para el sistema de altavoces y la aplicación a la que vayan destinados. Recomendamos utilizar accesorios de montaje Bose siempre que estén disponibles. Un ingeniero profesional con licencia deberá revisar el diseño y la fabricación de cualquier accesorio de montaje personalizado.
3. El conjunto de altavoces modulares Bose RoomMatch™ incorpora un sistema integrado de instalación mediante placa lateral diseñado para facilitar el montaje del conjunto de altavoces a los instaladores profesionales. Las conexiones entre módulos deberán realizarse utilizando sólo las placas laterales de instalación integradas con las abrazaderas de calidad M10 incluidas. ¡NO utilice accesorios roscados SAE de 3/8"! Utilice únicamente accesorios métricos. Las abrazaderas deberán ser de Clase 10.0 métrica (destinadas a soportar carga) o equivalentes. No deberán emplearse abrazaderas sin marca (no destinadas a soportar carga).
4. No suspenda el altavoz utilizando empuñaduras como puntos de fijación. **Las empuñaduras NO están destinadas a soportar cargas.**
5. Utilice arandelas de presión o un pegamento de fijación pensado para desmontaje manual, como LOCTITE® THREADLOCKER BLUE 242®, para conseguir un montaje resistente a vibraciones.
6. Las abrazaderas deberán apretarse con un par de 47 a 54 Newtons-metros (35 a 40 pies-libras). Si se aprietan en exceso las abrazaderas, se podría causar un daño irreparable a la caja y se crearía un ensamblado inseguro.
7. No intente alterar los puntos de fijación roscados ni volver a roscar los puntos de fijación para adaptarlos a otro tamaño o tipo de rosca; de hacerlo, comprometería la seguridad de la instalación, al tiempo que dañaría el altavoz de forma permanente.
8. Utilice un cable de seguridad, conectado a la caja por separado, en un punto distinto de los puntos de fijación del sistema de montaje y el altavoz que sustenten la carga. Esta práctica se recomienda aunque no lo requiera la normativa local. Consulte a un ingeniero profesional con licencia o a un profesional de instalación para conocer el diseño y la instalación adecuados.

 **PRECAUCIÓN:** Las matrices de altavoces instaladas requieren inspección periódica y mantenimiento rutinario para garantizar un funcionamiento correcto y seguro. Inspeccione en los accesorios y fijaciones de montaje si hay signos de corrosión, torceduras o cualquier otro problema que pueda reducir la integridad estructural. Sustituya inmediatamente los componentes desgastados o dañados.

 **PRECAUCIÓN:** No realice modificaciones en los altavoces o los accesorios de montaje. Las modificaciones no autorizadas pueden comprometer la seguridad y producir daños, lesiones o muerte.

 **PRECAUCIÓN:** No supere nunca 8 módulos RoomMatch utilizando las placas laterales de instalación integradas para el conjunto. Consulte las etiquetas del producto y los datos sobre límites de carga de trabajo en el documento Array Design and Installation Guide.

-  **L'installation de ce produit est réservée à un technicien professionnel !** Ce document à l'intention des installateurs professionnels contient les directives de pose et de sécurité relatives aux enceintes Bose RoomMatch™ en installation fixe. Lisez attentivement ce document avant l'installation.
-  **ATTENTION :** Tous les produits Bose® doivent être utilisés en respectant les réglementations locales et nationales. L'installateur est responsable du respect de tous les codes et règlements locaux et nationaux en vigueur applicables à l'installation et au montage des enceintes. Consultez les autorités locales compétentes avant d'installer ce produit.
-  **AVERTISSEMENT :** Tout montage non sécurisé d'une lourde charge peut provoquer des dégâts matériels et des blessures graves. Il en va de la responsabilité de l'installateur d'évaluer la fiabilité de toute méthode de montage utilisée pour cette application. Seul un installateur professionnel connaissant le matériel et les techniques de montage adaptées est qualifié pour installer des enceintes suspendues.

### Directives pour l'installation permanente d'un module d'enceinte Array RoomMatch™

Les directives d'installation contenues dans le présent document ne représentent que des conseils généraux et, à ce titre, ne présentent pas tous les critères et précautions de rigueur. En conséquence, toute personne utilisant ce document assume seule l'entière responsabilité de la sécurité d'installation de toutes les enceintes et de la configuration pratique de leur montage.

1. Avant l'installation de toute enceinte suspendue, il est nécessaire de faire approuver par un professionnel dûment autorisé l'emplacement et la méthode de fixation à la structure du bâtiment et de lui faire confirmer que cette fixation est conforme au code du bâtiment et aux réglementations. Il est important de s'assurer que la surface de montage et la méthode de fixation des enceintes à cette surface sont adaptées au poids total du système. Par sécurité, il est recommandé de respecter un rapport de poids de 10:1.
2. Tous les composants du système de montage doivent provenir d'un fabricant de bonne réputation. Le système de montage choisi doit être adapté aux enceintes et à l'utilisation prévue. Il est recommandé d'utiliser les accessoires de montage Bose disponibles. Faire contrôler par un professionnel qualifié la conception et la fabrication des accessoires de montage sur mesure.
3. Le module d'enceintes Array Bose RoomMatch™ est doté d'un système de fixation par plaque latérale intégré, destiné à en faciliter le montage par un installateur professionnel. La connexion entre deux modules doit être réalisée uniquement à l'aide des plaques latérales intégrées et des attaches M10 fournies. Ne PAS utiliser de composants filetés au pas SAE 3/8" ! Utilisez uniquement du matériel à mesure métrique. Les fixations doivent être de classe métrique 10.9 (pour la résistance à la charge) ou équivalente. Ne pas utiliser de fixations dont la classe de résistance à la charge n'est pas indiquée.
4. Ne pas utiliser les poignées de transport des enceintes comme points de suspension. **Ces poignées ne sont pas conçues pour supporter une charge permanente !**
5. Utiliser des rondelles de blocage ou une pâte à filets autorisant le démontage manuel (LOCTITE® THREADLOCKER BLUE 242®) pour réaliser un assemblage résistant aux vibrations.
6. Les attaches doivent être serrés avec un couple de 47 à 54 Nm). Si la force de serrage est trop importante, des dommages irréparables peuvent être causés au coffret de l'enceinte et rendre l'installation instable.
7. Ne tentez pas de modifier le filetage des points de fixation pour l'adapter à un autre type ou à une autre taille de filetage. Vous risqueriez de compromettre la sécurité de l'installation et d'endommager irrémédiablement l'enceinte.
8. Fixez un câble de sécurité, attaché séparément au coffret de l'enceinte, en un point autre que les points de fixation du système de montage de l'enceinte. Cette mesure est recommandée, même si elle n'est pas imposée par la réglementation locale. Pour la conception et la réalisation de l'installation, consultez un professionnel agréé.

 **ATTENTION :** une fois installées, les enceintes Array doivent faire l'objet d'une inspection et d'un entretien préventif afin de préserver leur fonctionnement en toute sécurité. Vérifiez que les composants et les points de fixation ne portent pas de traces de corrosion, de déformations ou autre signe de détérioration de leur intégrité structurelle. Remplacez immédiatement tout composant usé ou endommagé.

 **ATTENTION :** n'apportez aucune modification au système ou aux accessoires. Une modification non autorisée est susceptible de compromettre la sécurité et de provoquer un dommage ou un accident.

 **ATTENTION :** n'installez jamais plus de 8 modules RoomMatch à l'aide des plaques latérales intégrées. Reportez-vous aux étiquettes des produits et au Guide d'installation pour toutes données sur les limites de charge en fonctionnement.



**Dieses Produkt darf nur von fachkundigen Monteuren installiert werden!** Dieses Dokument soll fachkundigen Monteuren grundlegende Installations- und Sicherheitsrichtlinie für Bose RoomMatch™-Lautsprecher in typischen Festinstallationssystemen bieten. Bitte lesen Sie dieses Dokument vor der Installation durch.



**WARNUNG:** Alle Bose®-Produkte müssen gemäß den örtlichen und staatlichen Vorschriften sowie gemäß allen Branchenbestimmungen verwendet werden. Der Monteur ist dafür verantwortlich, sicherzustellen, dass die Installation der Lautsprecher und der Halterung gemäß allen geltenden Vorschriften durchgeführt wird, einschließlich örtlicher Bauvorschriften und Bestimmungen. Wenden Sie sich vor der Installation dieses Produkts an die zuständige Rechtsbehörde.



**WARNUNG:** Unsichere Befestigung oder ein Aufhängen über Kopf schwerer Lasten kann zu schweren Verletzungen und Sachschäden führen. Der Monteur ist dafür verantwortlich, die Zuverlässigkeit der für die Anwendung verwendeten Befestigungsmethoden zu prüfen. Nur fachkundige Monteure mit Wissen über ordnungsgemäße Befestigungselemente und sichere Befestigungstechniken sollten Lautsprecher über Kopf installieren.

## Richtlinien für die permanente Installation von RoomMatch™ Array-Modullautsprechern

Die in diesem Dokument enthaltenen Installationsinformationen sind nur eine allgemeine Richtlinie und können daher nicht alle Anforderungen und Vorsichtsmaßnahmen darstellen. Demgemäß übernimmt jeder, der dieses Material verwendet, die gesamte Haftung und ist ausdrücklich verantwortlich für die Sicherheit aller Lautsprecher-Array-Designs und Befestigungskonfiguration, die in der Praxis eingesetzt werden.

1. ) Vor der Installation von Lautsprechern über Kopf muss ein zugelassener fachkundiger Techniker den Ort und die Methode der Befestigung an der Gebäudestruktur prüfen und bestätigen, dass diese alle Bauvorschriften und Bestimmungen entspricht. Vergewissern Sie sich, dass die Befestigungsfläche und die Methode zum Befestigen des Lautsprechersystems an der Fläche geeignet ist, das Gesamtgewicht des Systems zu tragen. Es wird ein Sicherheitsfaktor von 10:1 empfohlen.
2. Beschaffen Sie sich alle Komponenten der Halterung von renommierten Herstellern. Wählen Sie eine Halterung, die für Ihr Lautsprechersystem und die beabsichtigte Anwendung geeignet ist. Wir empfehlen Befestigungszubehör von Bose, wo verfügbar. Ein zugelassener fachkundiger Techniker muss die Auslegung und die Herstellung der benutzerspezifischen Befestigungselemente überprüfen.
3. Bose RoomMatch™ Array-Modullautsprecher verfügen über ein integriertes Seitenplattenverankerungssystem, das die Montage des Lautsprecher-Arrays durch fachkundige Monteure erleichtern soll. Verbindungen zwischen den Modulen dürfen nur mithilfe der integrierten Verankerungsseitenplatten und den mitgelieferten M10-Befestigungselementen vorgenommen werden. Verwenden Sie KEINE Befestigungselemente mit einem SAE 3/8"-Gewinde. Verwenden Sie ausschließlich metrische Zubehörteile. Befestigungselemente müssen metrisch sein und der Klasse 10.9 (für das Tragen von Lasten geeignet) oder gleichwertig entsprechen. Nicht gekennzeichnete (nicht für das Tragen von Lasten geeignete) Befestigungselemente dürfen nicht verwendet werden.
4. Hängen Sie die Lautsprecher nicht mithilfe von Griffen als Befestigungspunkte auf. **Griffe sind NICHT für das Tragen von Lasten gedacht!**
5. Verwenden Sie Sicherungsscheiben oder eine Schraubensicherung, die eine Demontage ohne Werkzeuge ermöglicht, wie z.B. Loctite® THREADLOCKER BLUE 242®, um eine erschütterungsfeste Verbindung zu gewährleisten.
6. Die Befestigungselemente müssen mithilfe eines Drehmoments von 47 bis 54 Nm festgezogen werden. Verwenden Sie kein höheres Drehmoment, da dies Schäden an der Box zur Folge haben kann und die Sicherheit des Befestigungssystems beeinträchtigt wird.
7. Verändern Sie auf keinen Fall die Befestigungspunkte mit Gewinde oder Gewindegröße und -typ der Befestigungspunkte, da dies die Sicherheit der Installation beeinträchtigen und permanente Schäden am Lautsprecher zur Folge haben kann.
8. Bringen Sie ein zusätzliches Sicherungskabel an der Box an. Verwenden Sie hierzu nicht die tragenden Befestigungspunkte, die die Halterung mit dem Lautsprecher verbinden. Wir empfehlen diese Sicherheitsmaßnahme auch dann, wenn diese von den örtlichen Behörden nicht vorgeschrieben ist. Wenden Sie sich wegen der richtigen Auslegung und Installation an einen zugelassenen fachkundigen Techniker oder einen Montagespezialisten.



**ACHTUNG:** Installierte Lautsprecher-Arrays erfordern regelmäßige Inspektion und Routinewartung, um die ordnungsgemäße Funktion und den sicheren Betrieb zu gewährleisten. Überprüfen Sie die Befestigungselemente und das Zubehör auf Anzeichen von Korrosion, Verbiegen oder andere Zustände, die die strukturelle Integrität verringern können. Ersetzen Sie abgenutzte oder beschädigte Teile sofort.



**ACHTUNG:** Nehmen Sie keine Veränderungen an den Lautsprechern oder am Befestigungszubehör vor. Nicht genehmigte Änderungen können die Sicherheit beeinträchtigen und zu Schäden, Verletzungen oder Todesfällen führen.



**ACHTUNG:** Montieren Sie nie mehr als 8 RoomMatch-Module mithilfe der integrierten Verankerungsseitenplatten als Arrays. Daten zur Nutzlastgrenze finden Sie auf dem Typenschild und im Design- und Installationsanleitungsdokument des Array.

## Summary Description

RoomMatch™ Array Frame rigging accessories are designed for fixed-installation overhead suspension of RoomMatch™ full-range and subwoofer array modules. **Use with non-RoomMatch loudspeakers is not recommended.**

**RMAFSM Small Array Frame.** Use with 1 to 4 full-range or subwoofer array modules in overhead suspended arrays.

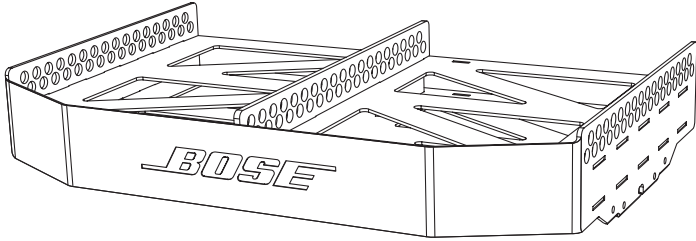

**RMAFLG Large Array Frame.** Use with 4 to 8 full-range or subwoofer array modules in overhead suspended arrays. Compatible with Long and Short Extender Bars (see below).

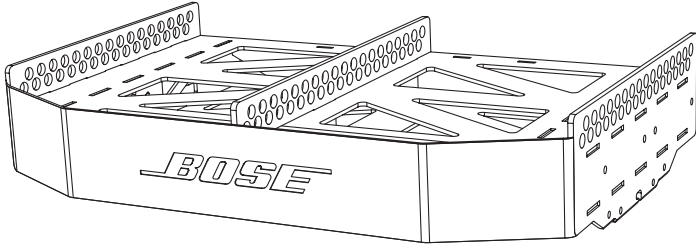

**RMXLNG Long Extender Bars.** Use with Large Array Frame to accommodate subwoofer module mounting behind primary array. Also provides additional shackle mounting pickup points to allow more extreme angles for 2-point mounting.

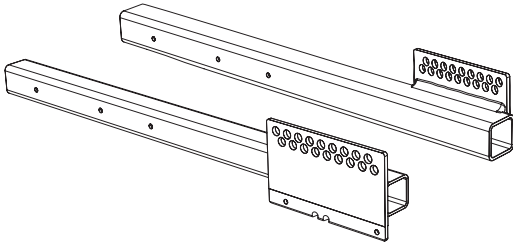

**RMXSRT Short Extender Bars.** Use with Large Array Frame to accommodate subwoofer module mounting behind primary array. Also provides additional shackle mounting pickup points to allow more extreme angles for 2-point mounting.

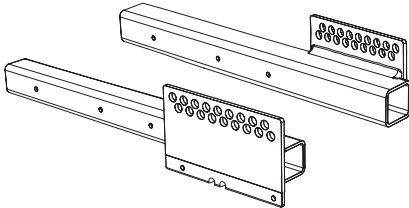

**RMPULL Pull Back Bar.** Use with bottom-most array module to provide third-point suspension to building structure to allow more extreme downward angle of arrays than possible from 2-point, gravity-hang suspension. The RMPULL can also be used as a “mini frame” for suspending 1 or 2 modules.

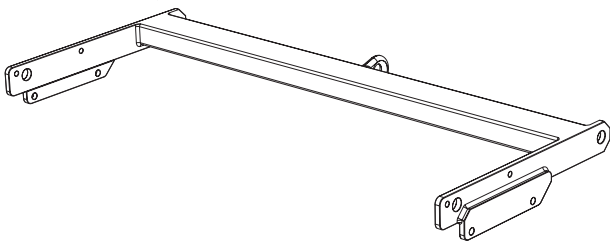



Refer to pro.Bose.com for additional specifications and installation information!

**RMAFSM**

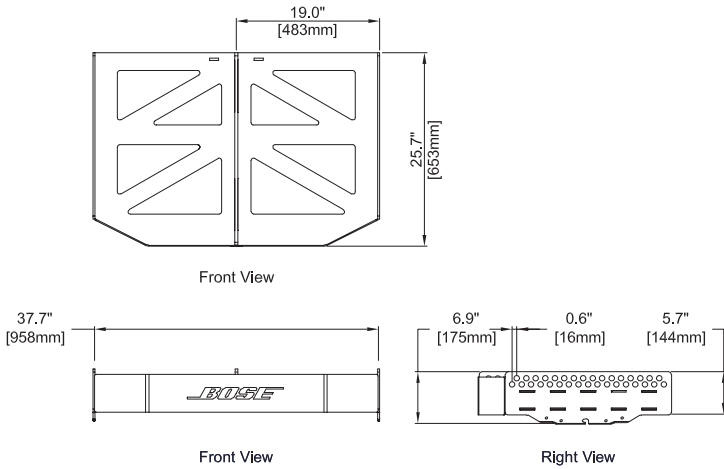

**RMAFLG**

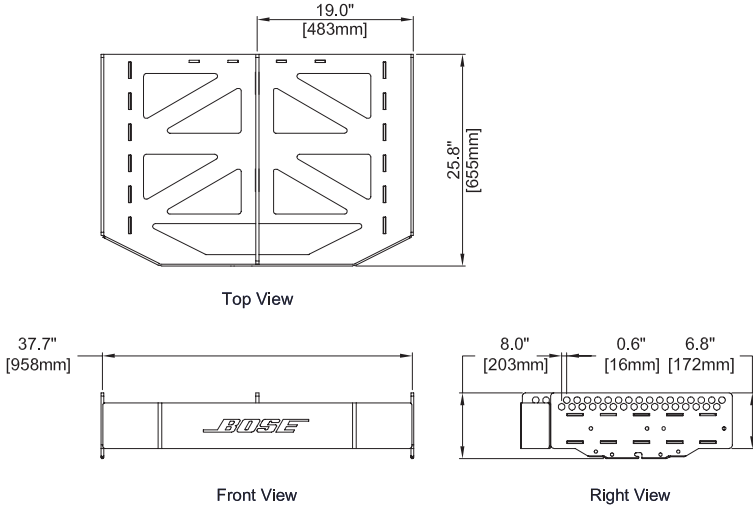

**RMXLNG**

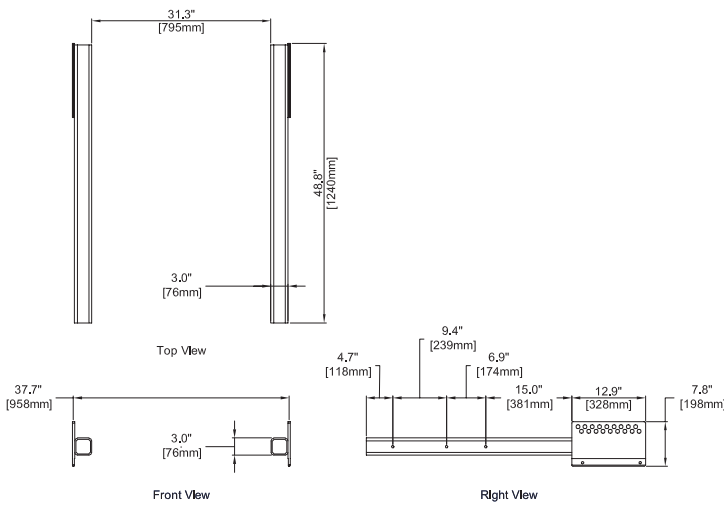

**RMXSRT**

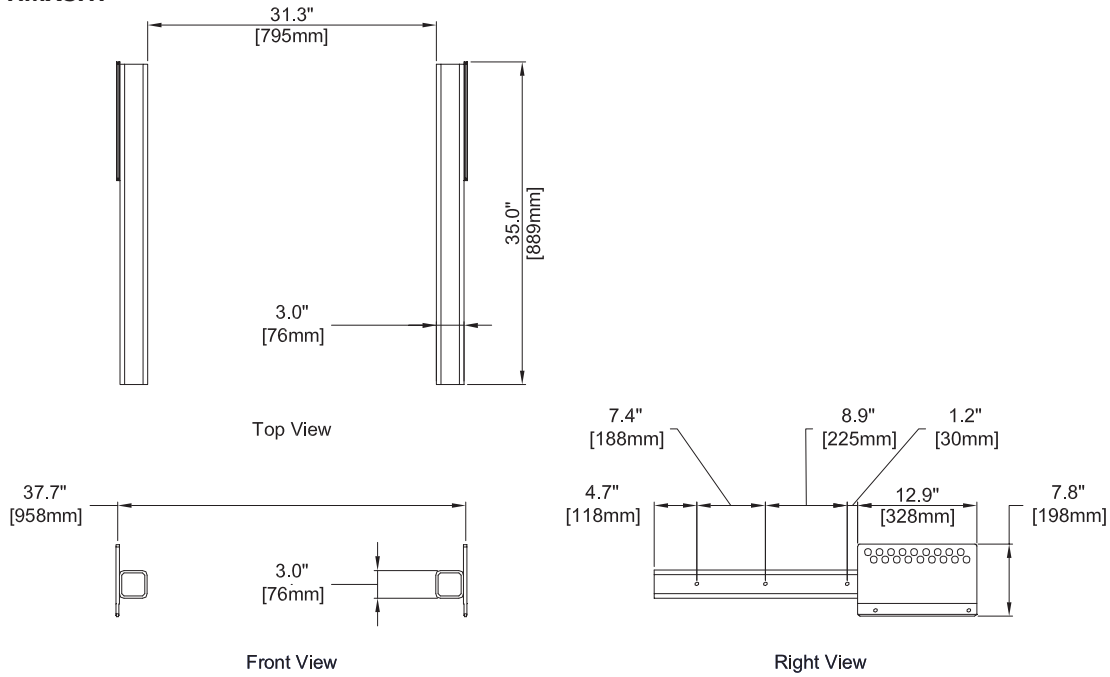

**RMPULL**

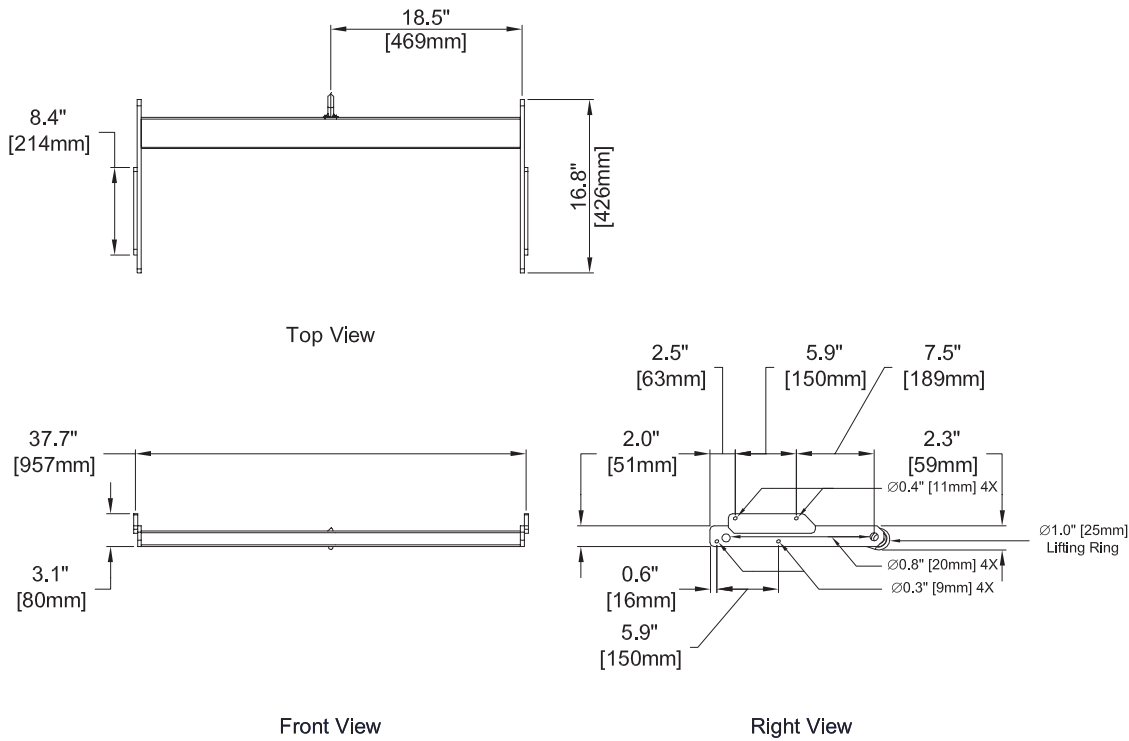



## Array Rigging

Each RoomMatch™ full-range module includes integrated side-plate array rigging hardware. The rigging system is designed to allow fast construction of typical fixed-installation arrays of up to 8 modules, while maintaining a 10:1 Safety Factor. Additionally, the RoomMatch™ RMS215 subwoofer is designed to integrate with full-range modules in arrays when the optional RMSFLY accessory part is installed on the subwoofer. To connect RoomMatch™ modules for suspended arrays, the following steps are recommended:

**Note:** Prior installation of field wiring and a safety-rated suspension system, e.g. chain-hoist motors or wire-rope slings, is assumed. Motors may be used as a permanent suspension method or to temporarily elevate an array to final position for attachment to conventional rigging hardware.

**Note:** All lifting operations require two individuals positioned on each side of the loudspeaker.

### Before You Begin – Recommended Tools

(2) 15 mm sockets and socket wrenches (module to module bolts: M10 x 30 mm)

(2) 17 mm sockets and socket wrenches (if using frame extender bars)

(2) 17 mm combination wrenches (for extender bar bolts)

(2) 5/16-inch Aligning Punch (optional; to aid bolt alignment)

## Preparing Modules for Installation

### Step 1

Retain orange-color Temporary Installation Handles included in package. Remove the RoomMatch™ modules from the shipping cartons, remove packing materials, and place the loudspeakers on the floor beneath planned suspension point.

**CAUTION:** Do not place loudspeakers resting on grills.

**CAUTION:** Place loudspeakers on a flat surface; verify loudspeaker weight is not supported by driver adapters.

### Step 2

Locate the temporary installation handles and thread onto each module (see module instruction sheet).

### Step 3

Remove four (4) M10 bolts from top of rigging side plates for each module (2 per side).

### Section A: Small or Large Array Frame (without Extender Bars)

1. Use *RoomMatch™ Array Suspension Angle Calculator* software to determine the hole positions on the array frames for required aiming angles and confirm array does not exceed load limits of frame.  
(You may also contact your local Bose Technical Support or Field Engineer for this information.)
2. Place array frame directly under the chain motors positioned for intended array location.
3. Attach 5/8 –inch forged steel frame shackles to array frame in hole positions determined by aiming software.
4. Lower chain motors and attach to shackles installed on array frame.
5. Raise array frame to height slightly greater than that of the 1st module (upper most) to be installed.  
**Note: subwoofer modules should always be placed in the upper-most array positions.**
6. With 1 person per side, place the 1st module directly under the suspended array frame. See Figure 1.
7. Lower the array frame onto the 1st module, guiding the pins of the temporary handles into the slots of the frame.
8. Using handles, pull the module forward to align the bolt holes of the module and frame. (Note: it may be helpful to use an alignment punch tool in the rear holes and then thread the bolts in the front holes first.)
9. Insert 4 bolts (2 per side) and finger tighten each until all bolts are installed.
10. Tighten all 4 bolts with socket tool using torque of 35 to 40 foot-pounds (47 to 54 Newton-meters).
11. Raise array frame to height slightly above that of 2nd module.
12. Position 2nd module directly under array.
13. With 1 person per side, lift the 2nd module and guide the temporary handle pins into the alignment slots of the 1st (top) module side plates. See Figure 2.
14. Holding the handles of the 1st (top) module stationary, pull forward on the handles of the 2nd (bottom) module to align the bolt holes of both modules.
15. Insert 4 bolts (2 per side) and finger tighten each until all bolts are installed.
16. Tighten all 4 bolts with socket tool using torque of 35 to 40 foot-pounds (47 to 54 Newton-meters).
17. Remove temporary installation handles from top module. Handles in module just installed should remain for now.
18. Repeat steps 11 – 16 for to install additional modules in the array. Do not exceed load limits of frame.
19. Remove any remaining temporary installation handles before elevating array to final height.
20. Connect field wiring, test loudspeaker operation, and then elevate array assembly to final operating position.

Figure 1. Positioning Frame on 1st Module

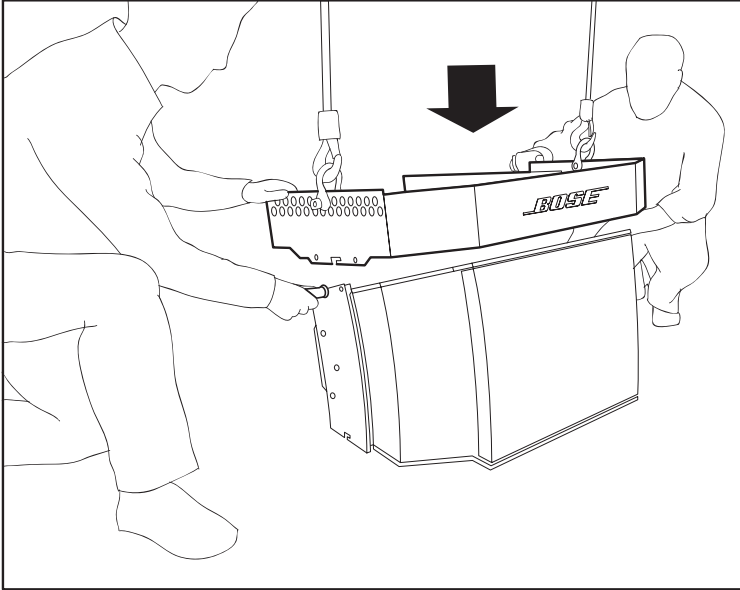
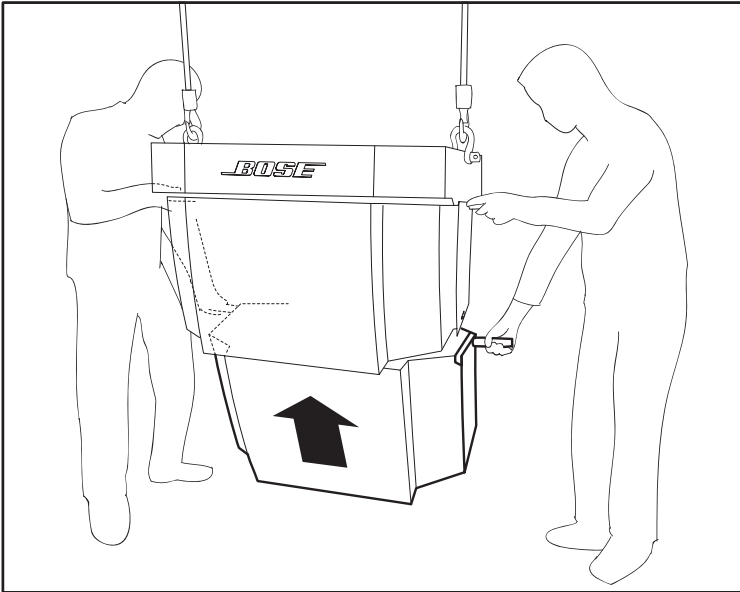

Figure 2. Attaching 2nd Module to 1st Module



For additional details on array configuration and installation, refer to the document *RoomMatch™ Array Design and Installation Manual* which is available for download at [pro.Bose.com](http://pro.Bose.com).

**Section B: Pull Back Bracket on Bottom Module**

The RMPULL pull-back bracket can be attached to the bottom module of an array to provide a third structural attachment point for more extreme downward tilt than is possible with 2-point suspension. However, the Pull Back Bracket is not intended to provide primary structural support for the entire array. The primary suspension points of the array frame should be as close as possible to the center of gravity of the array to minimize the tension load in the pullback cable. Use the *RoomMatch™ Array Suspension Angle Calculator* software to determine if the pull-back bracket is required and then to confirm that the pullback angle and working load is within acceptable safe limits.

1. In Section A above, follow steps 1 to 19 to assemble the array modules on the large or small array frame.
2. With the tabs of the RMPULL bracket facing **downward**, align the 4 bolt holes of the tabs with the 4 bolt holes of the bottom module sides plates. (Note: it may be helpful to use an alignment punch tool in the rear holes and then thread the bolts in the front holes first.)
3. Insert 4 bolts (2 per side) and finger tighten each until all bolts are installed.
4. Tighten all 4 bolts with socket tool using torque of 35 to 40 foot-pounds (47 to 54 Newton-meters).
5. Connect field wiring, test loudspeaker operation, and then elevate array assembly to final operating position.
6. Adjust length of pullback cable attached to eyebolt of RMPULL bracket as required for desired array tilt angle.

### Section C: Pull Back Bracket Used to Suspend 1-2 Array Modules

The RMPULL pull-back bracket can also be used as a “mini-frame” to suspend 1 or 2 full-range modules.

**WARNING:** Never use the RMPULL bracket as the primary support for more than 2 full-range modules.

When using the RMPULL bracket as the primary support frame, the following installation steps are recommended:

1. Place the RoomMatch array module on the ground near the intended suspension point.
2. With the tabs of the RMPULL bracket facing **downward**, align the 4 bolt holes of the tabs with the 4 bolt holes of the bottom module sides plates. (Note: it may be helpful to use an alignment punch tool in the rear holes and then thread the bolts in the front holes first.)
3. Insert 4 bolts (2 per side) and finger tighten each until all bolts are installed.
4. Tighten all 4 bolts with socket tool using torque of 35 to 40 foot-pounds (47 to 54 Newton-meters).
5. If only 1 module is to be suspended using the RMPULL bracket, skip to step number 12.
6. If 2 modules are to be suspended, connect shackles to the 4 mounting holes of the bracket and elevate module and bar assembly to height slightly above that of 2nd module to be suspended.
7. Place the 2nd RoomMatch array module on directly under the 1st module assembly.
8. With 1 person per side, lift the 2nd module and guide the temporary handle pins into the alignment slots of the 1st (top) module side plates.
9. Holding the handles of the 1st (top) module stationary, pull forward on the handles of the 2nd (bottom) module to align the bolt holes of both modules.
10. Insert 4 bolts (2 per side) and finger tighten each until all bolts are installed.
11. Tighten all 4 bolts with socket tool using torque of 35 to 40 foot-pounds (47 to 54 Newton-meters).
12. Remove temporary installation handles from top module.
13. Connect field wiring, test loudspeaker operation, and then elevate array assembly to final operating position.

**Note:** An additional RMPULL bracket can be mounted on the bottom of the module to provide pitch adjustment from a third suspension point.

## Section D: Large Array Frame with Extender Bars for Pick Points

The Large Array Frame with Extender Bars (Short or Long) can be used to provide additional pickup points for more extreme tilt angles. For this application, attach the Extender Bars to the Large Array Frame before attaching any modules using the following steps:

1. Use *RoomMatch™ Array Suspension Angle Calculator* software to determine the hole positions on the array frames for required aiming angles and confirm array does not exceed load limits of frame.
2. Locate the 2 extender bars noting the R (right) and L (left) markings on the labels.
3. Locate the Large Array Frame and position on the ground near the intended suspension point.
4. From the rear of the Large Array Frame, insert the bar marked L into the channel on the right side of the array frame. Note: the double rows of mounting holes should be facing upward.
5. Align the bolt holes with the intended position marker (OUT or IN) of the bar.
6. Insert 4 bolts (2 per side) and finger tighten each until all bolts are installed.
7. Tighten all 4 bolts with socket tool using torque of 35 to 40 foot-pounds (47 to 54 Newton-meters).
8. Repeat steps 3 to 6 for the R bar into the channel on the left side of the array frame (Note: the **L** and **R** markings on the extender bars assume viewing position in front of the array frame.)

With the Extender Bars now secured to the Large Array Frame, proceed to the steps outlined in Section A to continue constructing the array.

### Section E: Large Array Frame with Extender Bars for Cardioid Subwoofer

The Large Array Frame with Extender Bars (Short or Long) can also be used to mount RoomMatch subwoofer modules behind the primary array. The most common usage for this application is to provide a cardioid pattern for subwoofers with one subwoofer module directly behind the front subwoofer module. For this application, follow these steps:

1. Use *RoomMatch™ Array Suspension Angle Calculator* software to determine the hole positions on the array frames and/or Extender Bars for required aiming angles and confirm load limits are not exceeded.
2. Place array frame directly under the chain motors positioned for intended array location.
3. Locate the 2 extender bars noting the R (right) and L (left) markings on the labels.
4. From the rear of the Large Array Frame, insert the bar marked L into the Left pocket of the array frame. Note: the double rows of mounting holes should be facing upward and on the outside of the frame.
5. Align the bolt holes with the intended position marker (OUT or IN) of the bar.
6. Insert 4 bolts (2 per side) and finger tighten each until all bolts are installed.
7. Repeat steps 3 to 6 for the R bar into the Right pocket of array frame.
8. Attach 5/8 –inch forged steel frame shackles to array frame in hole positions determined by aiming software.
9. Lower chain motors and attach to shackles installed on array frame.
10. Raise array frame to height slightly greater than that of the subwoofer module.
11. Install RMSFLY side plate kit to RMS215 subwoofer modules following steps included with RMSFLY kit.
12. Position front RMS215 module directly under Large Array Frame
13. Position rear RMS215 module directly under mounting-hole tabs of Extender Bars
14. Lower the Array Frame/Extender Bar assembly to align the front holes of the Array Frame to the front holes of the front subwoofer module side plates. Insert an alignment punch into the rear holes of the front subwoofer side plates.
15. Thread 2 bolts (1 per side) into the front side-plate holes of the front subwoofer and finger tighten.
16. Lower the Extender Bars to align the rear holes of the Extender Bars to the rear holes of the rear subwoofer module side plates. Insert an alignment punch into the front holes of the rear subwoofer side plates.
17. Thread 2 bolts (1 per side) into the rear side-plate holes of the rear subwoofer and finger tighten.
18. Remove alignment punches and thread 2 bolts (1 per side) into the front side plate holes of the rear subwoofer and finger tighten.
19. Thread 2 bolts (1 per side) into the rear side plate holes of the front subwoofer and finger tighten.
20. Tighten all 8 bolts with socket tool using torque of 35 to 40 foot-pounds (47 to 54 Newton-meters).
21. Raise array assembly to height slightly above that of the next array module to install.
22. To install additional modules suspended from the side plates of the front subwoofer module, follow steps 6 to 20 as outlined in Section A of this document.

**Note:** For information regarding cardioid subwoofer performance and extender bar positions, please refer Figure 3.

Figure 3. RoomMatch™ RMS215 subwoofer module performance versus Extender Bar Positions

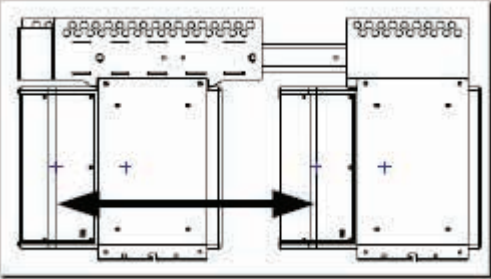
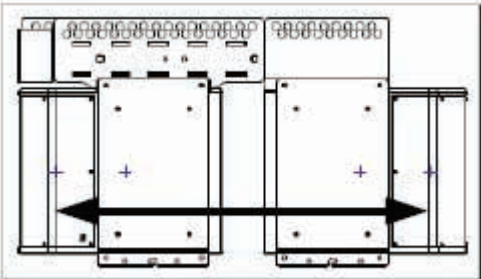
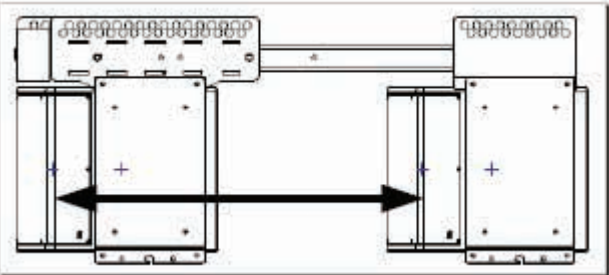
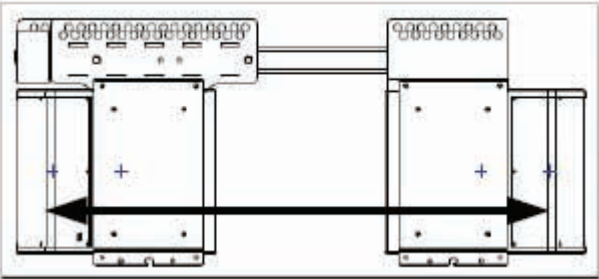
Large Array Frame with Extender Bar Type and Mounting Position	Rear Sub Orientation	Pattern Control	Cross-Over	Advantages and Disadvantages
<p><b>RMXSRT Short Extender Bar – OUT Position</b></p>  <p>The diagram shows a top-down view of a large array frame with two subwoofer modules. A short extender bar is mounted on the right side of the right module, extending outwards. A double-headed arrow indicates a driver spacing of 0.7 m between the two modules.</p>	<p>Forward Firing</p> <p>0.7 m driver spacing</p>	<p>&gt;120 Hz</p>	<p>100 Hz or 120 Hz</p>	<p>+ Small Footprint  - No Pattern Control</p>
<p><b>RMXSRT Short Extender Bar – IN Position</b></p>  <p>The diagram shows a top-down view of a large array frame with two subwoofer modules. A short extender bar is mounted on the right side of the right module, extending inwards towards the center. A double-headed arrow indicates a driver spacing of 1.0 m between the two modules.</p>	<p>Rear Firing</p> <p>1.0 m driver spacing</p>	<p>&gt;85 Hz</p>	<p>100 Hz</p>	<p>+ Audible control + Small footprint  - Less “punchy” bass - Audible rear lobe</p>
<p><b>RMXLNG Long Extender Bar – OUT Position</b></p>  <p>The diagram shows a top-down view of a large array frame with two subwoofer modules. A long extender bar is mounted on the right side of the right module, extending outwards. A double-headed arrow indicates a driver spacing of 1.0 m between the two modules.</p>	<p>Front Firing</p> <p>1.0 m driver spacing</p>	<p>&gt;85 Hz</p>	<p>80 Hz or 100 Hz</p>	<p>+ Best audible control + Best “punchy” bass  - Largest footprint</p>
<p><b>RMXLNG Long Extender Bar – IN Position</b></p>  <p>The diagram shows a top-down view of a large array frame with two subwoofer modules. A long extender bar is mounted on the right side of the right module, extending inwards towards the center. A double-headed arrow indicates a driver spacing of 1.2 m between the two modules.</p>	<p>Rear Firing</p> <p>1.2 m driver spacing</p>	<p>&gt;63 Hz</p>	<p>80 Hz</p>	<p>+ Control to 63 Hz  - Large footprint - Less control at 100 Hz</p>

Visit us on the web at [pro.Bose.com](http://pro.Bose.com).

**Americas**

(USA, Canada, Mexico, Central America, South America)  
Bose Corporation  
The Mountain  
Framingham, MA 01701 USA  
Corporate Center: 508-879-7330  
Americas Professional Systems,  
Technical Support: 800-994-2673

**Australia**

Bose Pty Limited  
Unit 3/2 Holker Street  
Newington NSW Australia  
61 2 8737 9999

**Belgium**

Bose N.V. / S.A  
Limesweg 2, 03700  
Tongeren, Belgium  
012-390800

**China**

Bose Electronics (Shanghai) Co Ltd  
36F, West Gate Tower  
1038 West Nanjing Road  
Shanghai, P.R.C. 200041 China  
86 21 6271 3800

**France**

Bose S.A.S  
12 rue de Temara 78100  
St. Germain-en-Laye, France  
01-30616363

**Germany**

Bose GmbH  
Max-Planck Strasse 36D 61381  
Friedrichsdorf, Deutschland  
06172-7104-0

**Hong Kong**

Bose Limited  
Suites 2101-2105, Tower One, Times Square  
1 Matheson Street, Causeway Bay, Hong Kong  
852 2123 9000

**India**

Bose Corporation India Private Limited  
4th Floor, Shriram Bhartiya Kala Kendra  
1, Copernicus Marg  
New Delhi 110001, India  
91 11 23073825

**Italy**

Bose SpA  
Via Della Magliana 87600148  
Rome, Italy  
066-5670802

**Japan**

Bose K.K., Shibuya YT Building  
28-3 Maruyama-sho  
Shibuya-ku, Tokyo 150  
TEL 3-5489-0955  
[www.bose.co.jp](http://www.bose.co.jp)

**The Netherlands**

Bose BV  
Nijverheidstraat 8 1135 GE  
Edam, Nederland  
0299-390139

**United Kingdom**

Bose Ltd  
1 Ambley Green, Gillingham Business Park  
KENT ME8 0NJ  
Gillingham, England  
0870-741-4500

**See website for other countries**



***BOSE***<sup>®</sup>  
*Better sound through research*<sup>®</sup>

© 2011 Bose Corporation. All rights reserved.  
The Mountain, Framingham, MA 01701-9168 USA  
[www.pro.Bose.com](http://www.pro.Bose.com)  
All trademarks are the property of their respective owners.  
AM346847 Rev. 00